

Article number: 03462017  
 Description: Fluro Rod end EA 17  
 Note: 17

## Measures

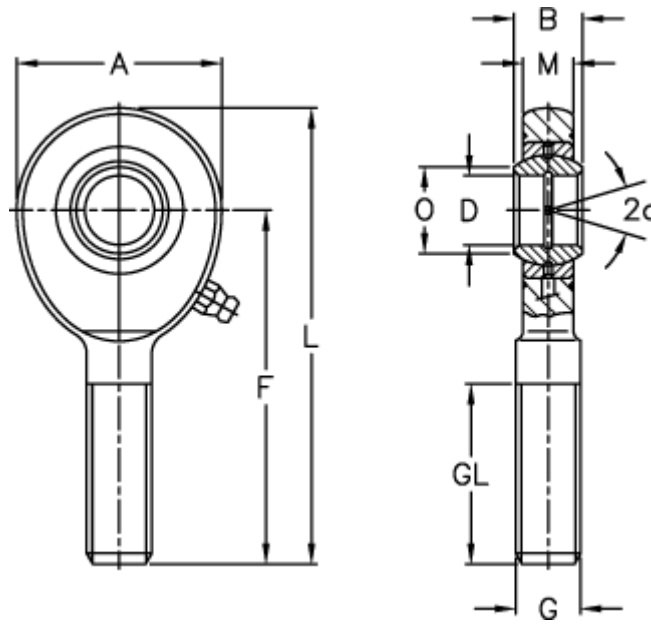

A	= 46	L	= 92
a (degrees)	= 10	M	= 11
B	= 14	O	= 20.7
D	= 17	Static drive kN	= 54
Dynamic drive (kN)	= 21.2	Weight	= 190
F	= 69		
g	= M16		
GL	= 36		